

S07924

INSTALLATION INSTRUCTIONS SHEET

START FROM HERE

- Make sure power is completely off at the fuse box.
- Have your fixture installed by a qualified licensed electrician
- Prepare everything in clear area.
- Wear gloves at all times during this installation.
- Read instructions carefully before you start assembly.
- Keep this instruction sheet for future reference.

Technical Support: 1-844-628-8368

Please Note:

- All Matteo Lighting fixtures come with pre-wired module(s).
- Unless instructed to do so, please do not touch any part of the module(s) as unnecessary contact with the module could cause permanent damage.

THIS LUMINAIRE MUST BE MOUNTED OR SUPPORTED IN A JUNCTION BOX
*CE LUMINAIRE DOIT ÊTRE MONTÉ OU SUPPORTÉ DANS UNE BOÎTE
DE JONCTION*

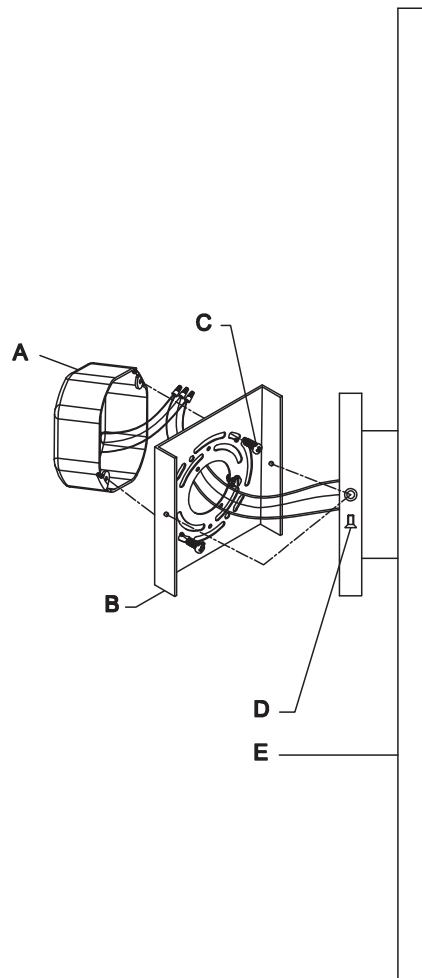

- Ensure main supply is switched off.
- Use M4 screws (C) to fix the mounting bracket (B) onto junction box (A).
- Connect wires according to color (White to White, Black to Black), connect all earth lug together onto the crossbar with green screw to tight.
- Fix canopy and body (E) onto mounting bracket with M4 screws (D).
- Reconnect power.
- Lamping: AC LED 120V 17W 3000K/4000K/5000K, CRI90

WARNING:

- This fitting must be earthed.
- Disconnect power and allow fitting to cool down before cleaning or changing the lamp.

start here

After securing fixture to the wall it is recommended that the gap between the wall and the fixture backplate be sealed on the top and both sides, with a good quality waterproof caulk or silicone sealant (NOT INCLUDED)-see Drawing 1.

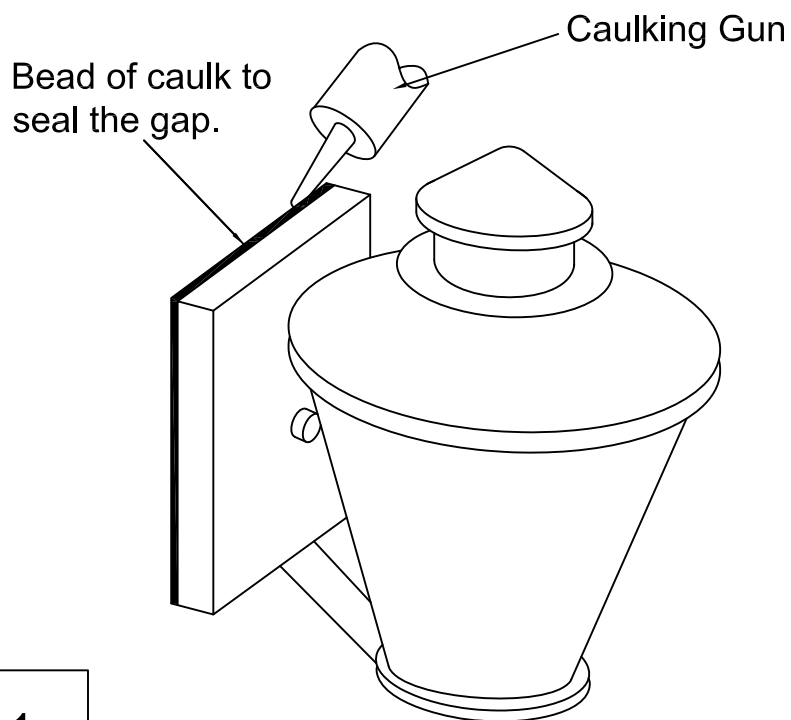

Drawin g 1

After securing fixture in place it is recommended that the gap between the mounting top and flxture base be sealed with any good quality waterproof caulk or silicone sealant (not included).It is also recomm ended that a small bead of caulk or sealant be put under the ball knobs used to mount fixture-see Drawing2.

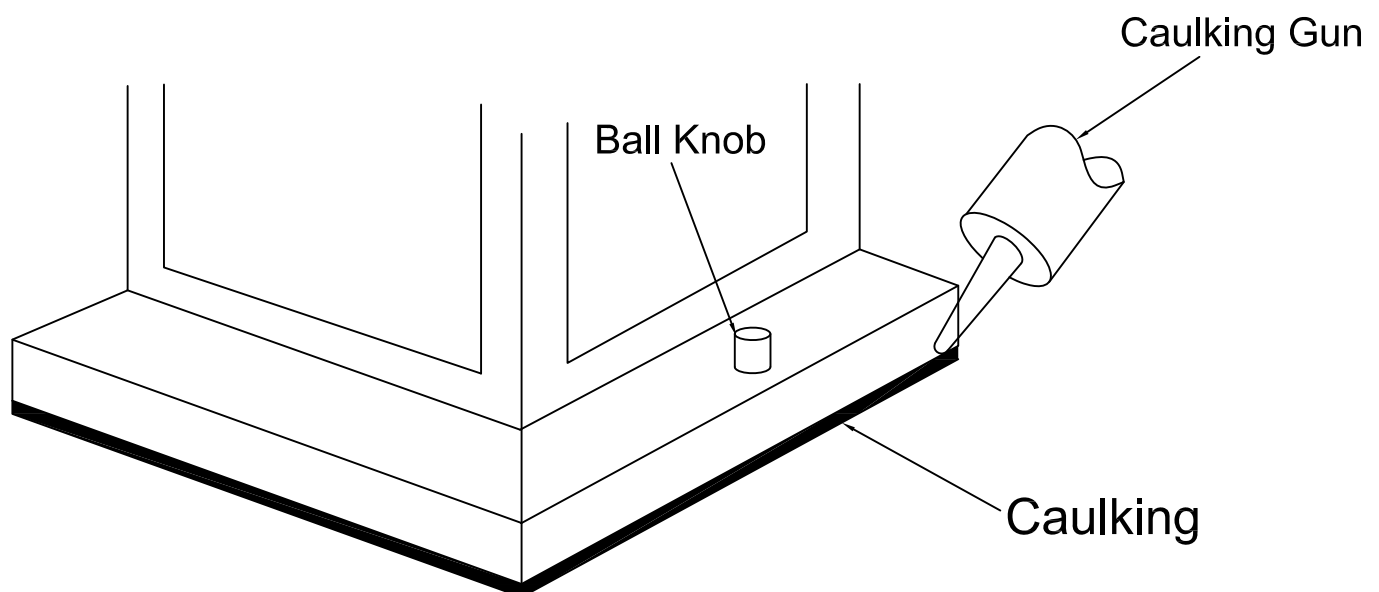

Drawin g 2