

Family: Miley | Item No. 5052

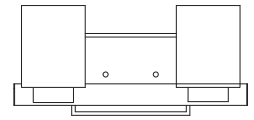

Drawing 1 - Strap Detail

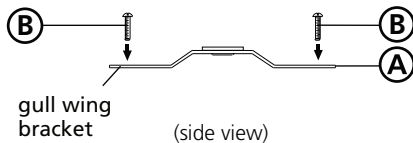

Drawing 2 - Fixture Mounting

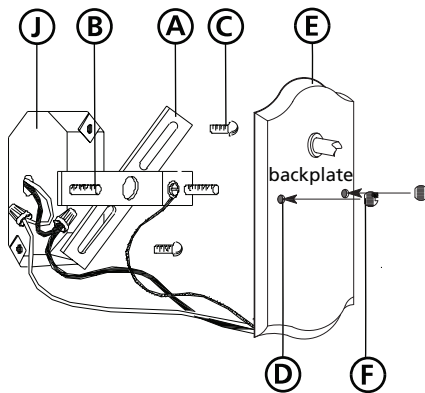

Drawing 3 - Fixture Assembly

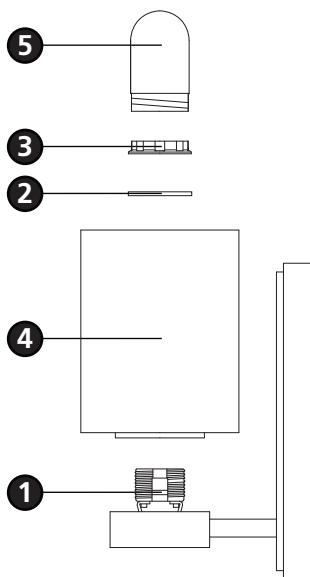

▼ start here

1

1. Find a clear area in which you can work.
2. Unpack fixture and glass from carton.
3. Carefully review instructions prior to assembly.

***** The construction of this fixture will be accomplished by first mounting the mounting strap to the junction box, making all necessary electrical connections, mounting the fixture to the wall, and then installing the fixture glass.**

2

1. Prepare mounting strap (A) by threading the two mounting screws (B) into the back of the gull wing bracket - see **Drawing 1**.
 - Be sure the holes into which the screws are threaded match the spacing of holes (D) in the back plate (E) - see **Drawings 1 and 2**.
2. Attach mounting strap (A) to junction box (J) using two 1" screws (C) not provided - see **Drawing 2**

SAFETY WARNING: READ WIRING AND GROUNDING INSTRUCTIONS (I.S. 18) AND ANY ADDITIONAL DIRECTIONS. TURN POWER SUPPLY OFF DURING INSTALLATION. IF NEW WIRING IS REQUIRED, CONSULT A QUALIFIED ELECTRICIAN OR LOCAL AUTHORITIES FOR CODE REQUIREMENTS.

3

Make electrical connections from supply wire to fixture lead wires. Refer to instruction sheet (I.S. 18) and follow all instructions to make all necessary wiring connections. Then refer back to this sheet to complete installation of this fixture.

4

1. To mount fixture, slide backplate (E) over screws (B) and secure with ball knobs (F) - see **Drawing 2**.

5

1. To install glass, remove threaded socket ring (3) and washer (2) from socket (1) - see **Drawing 3**.
2. Place glass (4) over exposed section of socket (1).
3. Slip washer (2) and thread socket ring (3) onto socket (1) to secure glass (4).
Note: Due to variations in glass thickness, spacer is optional.
4. Fixture can now be lamped accordingly.
5. Thread glass shield (5) onto socket (1).

Drawing 1 - Flush Mount



Drawing 2 - Chain Hung



Drawing 3 - Post-Mount

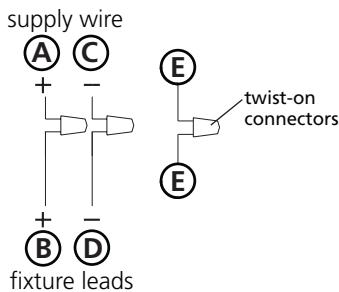

SAFETY WARNING: READ WIRING AND GROUNDING INSTRUCTIONS (I.S. 18) AND ANY ADDITIONAL DIRECTIONS. TURN POWER SUPPLY OFF DURING INSTALLATION. IF NEW WIRING IS REQUIRED, CONSULT A QUALIFIED ELECTRICIAN OR LOCAL AUTHORITIES FOR CODE REQUIREMENTS.

wiring instructions

Indoor Fixtures

1. Connect positive supply wire **(A)** (typically black or the smooth, unmarked side of the two-conductor cord) to positive fixture lead **(B)** with appropriately sized twist on connector - see **Drawings 1 or 2**.
2. Connect negative supply wire **(C)** (typically white or the ribbed, marked side of the two-conductor cord) to negative fixture lead **(D)**.
3. Please refer to the **grounding instructions** below to complete all electrical connections.

Outdoor Fixtures

1. Connect positive supply wire **(A)** (typically black or the smooth unmarked side of the two-conductor cord) to positive fixture lead **(B)** with appropriately sized twist on connector - see **Drawings 2 or 3**.
2. Connect negative supply wire **(C)** (typically white or the ribbed, marked side of the two-conductor cord) to negative fixture lead **(D)**.
3. Cover open end of connectors with silicone sealant to form a watertight seal.
 - If installing a wall mount fixture, use caulk to seal gaps between the fixture mounting plate (backplate) and the wall. This will help prevent water from entering the outlet box. If the wall surface is lap siding, use caulk and a fixture mounting platform specially.
4. Please refer to the **grounding instructions** below to complete all electrical connections.

grounding instructions

Flush Mount Fixtures

For positive grounding in a 3-wire electrical system, fasten the fixture ground wire **(E)** (typically copper or green plastic coated) to the fixture mounting strap **(1)** with the ground screw **(2)** - see **Drawing 1**.

Note: On straps for screw supported fixtures, first install the two mounting screws in strap. Any remaining tapped hole may be used for the ground screw.

Chain Hung Fixtures

Loop fixture ground wire **(E)** (typically copper or green plastic coated) under the head of the ground screw **(2)** on fixture mounting strap **(1)** and connect to the loose end of the fixture ground wire directly to the ground wire of the building system with appropriately sized twist-on connectors - see **Drawing 2**.

Post-Mount Fixtures

Connect fixture ground wire **(E)** (typically copper or green plastic coated) to power supply ground with appropriately sized twist-on connector inside post. Cover open end of connector with silicone sealant to form a watertight seal - see **Drawing 3**.

▼ Start Here

▼ Empieza aqui

▼ Commencer ici

Drawing 1 - Incandescent

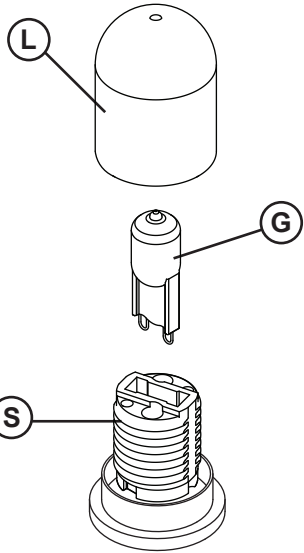

This fixture is packed with a G9 incandescent bulb as well as a G9 LED bulb. Please follow these directions carefully.

If using incandescent bulbs:

1. Fixture can only be hung with the bulbs facing up.
2. After installation, place bulb (G) into socket (S). See Drawing 1.
3. Screw on bulb shield (L). Bulb shield only needs to be turned a few times, it does not need to touch the bulb. **Bulb shields MUST be used with incandescent bulbs.**

If using LED bulbs:

1. Fixture can be hung either with bulbs facing down or up.
2. After installation, place bulb (D) into socket (S). See Drawing 2.

Note: if using LED bulb, do not discard incandescent bulb or bulb shield. These can be used as a replacement later if necessary.

Este accesorio se embala con una bombilla incandescente G9 así como un bulbo del LED G9. Siga estas instrucciones cuidadosamente.

Si utiliza bombillas incandescentes:

1. El accesorio sólo se puede colgar con las bombillas hacia arriba.
2. Después de la instalación, coloque la bombilla (G) en el zócalo (S). Vea Dibujo 1.
3. Enrosque la protección de la bombilla (L). El protector de la lámpara sólo necesita ser girado unas cuantas veces, no necesita tocar la bombilla. **Los bulbos deben ser utilizados con bombillas incandescentes.**

Si utiliza bombillas LED:

1. El accesorio se puede colgar con bulbos hacia abajo o hacia arriba.
2. Después de la instalación, coloque la bombilla (D) en el zócalo (S). Consulte el Dibujo 2.

Nota: si utiliza la bombilla LED, no deseche la bombilla incandescente o el protector de la bombilla. Éstos se pueden utilizar como reemplazo más adelante si es necesario.

Ce luminaire est emballé avec une ampoule incandescente G9 ainsi que d'une ampoule LED G9. Veuillez suivre ces instructions attentivement.

Si vous utilisez des ampoules à incandescence:

1. Fixation ne peut être suspendu avec les ampoules vers le haut.
2. Après l'installation, placer l'ampoule (G) dans la douille (S). Voir Dessin 1.
3. Vissez le bouclier de l'ampoule (L). Le bouclier d'ampoule seulement doit être tourné quelques fois, il n'a pas besoin de toucher l'ampoule. **Les ampoules doivent être utilisées avec des ampoules incandescentes.**

Si vous utilisez des ampoules LED:

1. Fixation peut être accroché soit avec des ampoules vers le bas ou vers le haut.
2. Après l'installation, placer l'ampoule (D) dans la douille (S). Voir Dessin 2.

Remarque: Si vous utilisez une ampoule à DEL, ne jetez pas d'ampoule incandescente ou d'ampoule. Ceux-ci peuvent être utilisés comme un remplacement plus tard si nécessaire.

Drawing 2 - LED

